

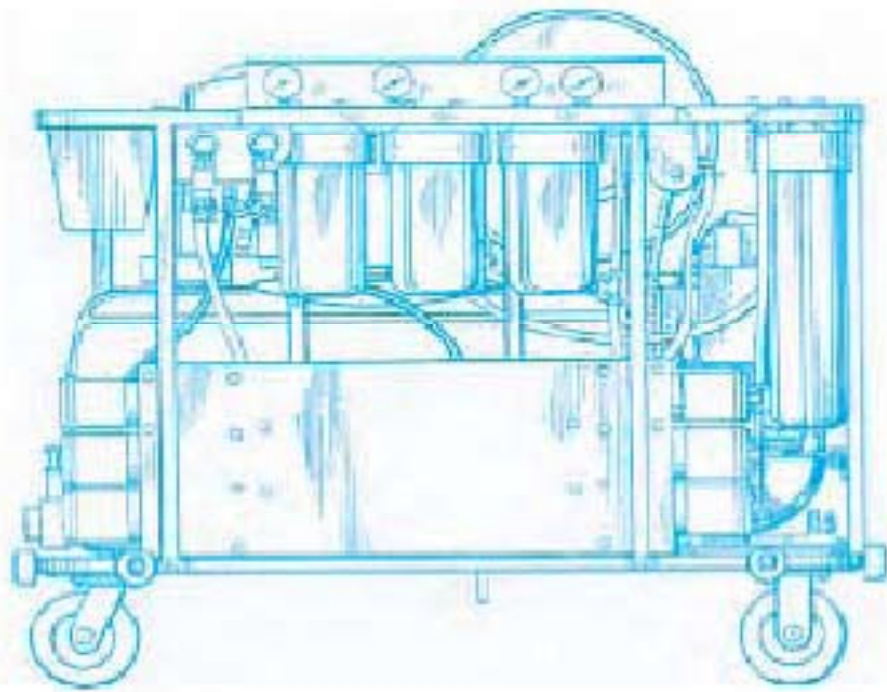

2008 Catalog



The **ULTIMATE**  **GREEN** cleaning machine™

PURE RINSE

Pure Rinse Systems, Inc
700 McKinley St. NW
Anoka MN, 55303
Ph: 763.433.0303
Fax: 764.433.0404
www.purerinse.com

RO Anywhere

The RO Anywhere from Pure Rinse Systems is designed for versatility, portability and performance in one user-friendly, service-friendly system — at an unbeatable price. Its modular design allows you to easily add capacity as your needs grow. The optional deionization (DI) cartridge is available to further purify the RO water for the most demanding spot-free cleaning applications and quickly mounts directly to the frame for a space efficient set-up.

Use your unit as a stationary installation in your shop or as a mobile system in your trailer, van or truck. Choose the either 900, 1800 or 2700 gpd (1.9 gpm, 77°F water) capacity unit for your specific needs.



FEATURES

- High Rejection RO membranes remove 99% of tap water impurities
- Triple pre-filtration for excellent membrane and system protection and long service intervals
- High-efficiency pump system is designed to maximize membrane life, quality and pure water production rate.
- Epoxy coated steel frame made with modular components for fast and easy servicing
- Vibration mounting of each frame platform for quiet, reduced-vibration operation
- High efficiency 115 VAC pumping system
- Easy-to-add DI cartridge option
- "Safety First" design, GFCI on each power cord

SPECIFICATIONS

- Capacity: 900, 1800, 2700 gpd (water @ 77°F)
- Pre-filter: 10 x 4.25", 5µ micron, Pleated
- Carbon filter: 10 x 4.0" Carbon
- Final filter: 10 x 4.25", 1micron, Depth
- Membranes: Thin Film Composite, High Rejection
- Housing: PVC and Glass-filled polyester resin
- Pump: PUMPTEC Model 348, 2.5 gpm at 200 psi
- Motor: 1/2 hp, 115/230 vac, 7.2/3.6 fla, 1.15 sf
- Regulator: PUMPTEC 500-200, adjustable 0-200 psi
- Gauges: Industrial grade, Glycerine filled, SS bodies
- Size: 15d x 30w x 37"h
- Weight: 150 lbs dry

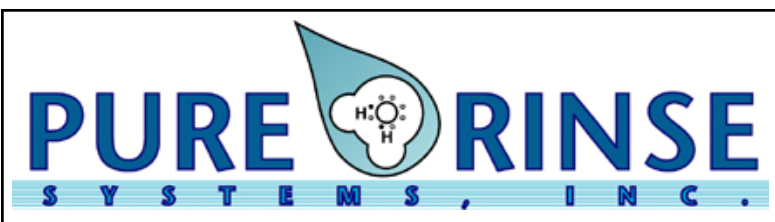

Pure Rinse Systems, Inc
700 McKinley St. NW
Anoka MN, 55303
Ph: 763.433.0303
Fax: 764.433.0404
www.purerinse.com

RO Tank

The RO Tank from Pure Rinse Systems is a high capacity 3000 GPD Reverse Osmosis (RO) unit and storage tank in one! The unit is designed to have remarkable installation flexibility for either stationary or mobile applications — with its recessed tank design, the unit can be even be mounted over the wheel well of a van, truck or trailer.

The options for a pure water distribution pumping system and auto-fill/shut-off system make this unit an unbeatable, compact solution for pure water production and storage.



FEATURES

- High Rejection RO membranes remove 99% of tap water impurities
- Triple pre-filtration for excellent membrane and system protection and long service intervals
- High-efficiency pump system is designed to maximize membrane life, quality and pure water production rate.
- Epoxy coated steel frame made with modular components for fast and simple servicing
- Vibration mounting of each frame platform for quiet, reduced-vibration operation
- 115 VAC pumping system
- "Safety First" design GFCI on each power cord

SPECIFICATIONS

- Capacity: 3000 gpd (water @ 77°F)
- Pre-filter: 10 x 4.25", 5μ, Pleated
- Carbon filter: 10 x 4.0" Carbon
- Final filter: 10 x 4.25", 1μ, Depth
- Membranes: Thin Film Composite, High Rejection
- Housing: PVC and Glass-filled Polyester resin
- Pump: PUMPTEC, 2.5 gpm at 200 psi
- Motor: 1/2 hp, 115/230 vac, 7.2/3.6 fla, 1.15 sf
- Regulator: PUMPTEC 500-200, adjustable 0-200 psi
- Gauges: Industrial grade, Glycerine filled, SS bodies
- Size: 21d x 62w x 45"h
- Weight: 200 lbs dry

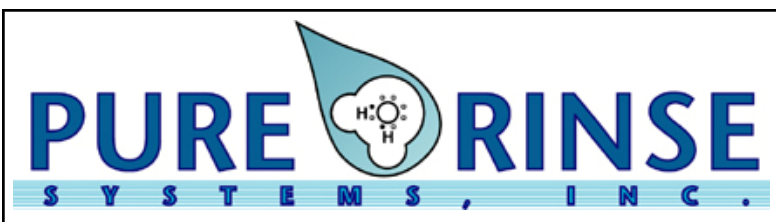

Pure Rinse Systems, Inc
700 McKinley St. NW
Anoka MN, 55303
Ph: 763.433.0303
Fax: 764.433.0404
www.purerinse.com

RO A La Kart

The RO A La Kart from Pure Rinse Systems is a complete Reverse Osmosis (RO) and Deionization (DI) system in one. The built-in DI cartridge further purifies the RO water for use in the most demanding spot-free cleaning applications. Maintenance is effortless with easy access to every major component of the system.

Designed to move easily from job site to job site, it's frame is only 27" wide and fits through the smallest doorways. The large pneumatic wheels allow easy movement and loading/unloading. For storage options, the unit can be stowed either horizontally or vertically. Also, the top control panel puts the controls within easy reach and view with panel-mounted pressure regulator, pressure gauges and water connections. The lower tray comes in handy for tool, hose and cord storage.

Use the RO A La Kart with the Pure Rinse Water Wagon for an outstanding flexible and complete system solution.



FEATURES

- High Rejection RO membranes remove 99% of tap water impurities
- Triple pre-filtration for excellent membrane and system protection and long service intervals
- High-efficiency pump system is designed to maximize membrane life, quality and pure water production rate.
- Epoxy coated steel frame made with modular components for fast and simple servicing.
- Vibration mounting of each frame platform for quiet, reduced-vibration operation
- 115 VAC pumping system
- "Safety First" design GFCI on each power cord

SPECIFICATIONS

- Capacity: 3000 gpd (Water @ 77°F)
- Pre-filter: 10 x 4.25", 5 μ , Pleated
- Carbon filter: 10 x 4.0" Carbon
- Final filter: 10 x 4.25", 1 μ , Depth
- Membranes: Thin Film Composite, High Rejection
- Housing: PVC and Glass-filled Polyester resin
- DI Cartridge: 4.5 x 20", Mixed Bed
- Pump: PUMPTEC, 2.5 gpm at 200 psi
- Motor: 1/2 hp, 115/230 vac, 7.2/3.6 fla, 1.15 SF
- Regulator: PUMPTEC 500-200, adjustable 0-200 psi
- Gauges: Industrial grade, Glycerine filled, SS bodies
- Size: 31d x 27w x 51"h
- Weight: 200 lbs dry



Pure Rinse Systems, Inc
700 McKinley St. NW
Anoka MN, 55303
Ph: 763.433.0303
Fax: 764.433.0404
www.purerinse.com

RO Trolley

The RO Trolley from Pure Rinse Systems is an all-in-one patented mobile design that combines a high capacity 3000 GPD Reverse Osmosis (RO) unit with a storage and distribution system. The high flow, high pressure distribution system is ideal for applications such as water-fed pole window cleaning and allows for the use of up to 3 poles and hose lengths of up to 600 feet!

The optional deionization (DI) system attaches easily for further polishing of the RO water for the most demanding spot-free cleaning jobs. RO followed by DI is the most economical and efficient way to make spot free rinsing water and the RO Trolley is a great way to produce it on site.



FEATURES

- High Rejection RO membranes remove 98% of tap water impurities
- Triple pre-filtration for excellent membrane and system protection and long service intervals
- High-efficiency pump system is designed to maximize membrane life, quality and pure water production rate.
- Epoxy coated steel frame made with modular components for fast and simple servicing.
- Vibration mounting of each frame platform for quiet, reduced-vibration operation
- Large 18" hose reel includes 300 ft. of non-marking high pressure hose
- Two auxiliary outlets for system flexibility
- 115 VAC pumping system
- Easy-to-add DI cartridge option
- "Safety First" design, GFCI on power cord

SPECIFICATIONS

- Capacity: 3000 gpd (water @ 77°F)
- Pre-filter: 10 x 4.25", 5 micron, Pleated
- Carbon filter: 10 x 4.0" Carbon
- Final filter: 10 x 4.25", 1 micron, Depth
- Membranes: Thin Film Composite, High Rejection
- RO Housings: PVC and Glass-filled Polyester Resin
- Pumps: PUMPTEC Model 356, 2.5 gpm/200 psi
- Motors: 1/2 hp, 115/230 vac, 7.2/3.6 fla, 1.15 sf
- Regulators: PUMPTEC 500-200, adj. 0-200 psi
- Gauges: Industrial grade, Glycerine filled, SS bodies
- 18" hose reel with 300 ft of non-marking hose installed, integral hose guide
- Size: 32d x 57w x 52h
- Weight: 300 lbs dry



Pure Rinse Systems, Inc
700 McKinley St. NW
Anoka MN, 55303
Ph: 763.433.0303
Fax: 764.433.0404
www.purerinse.com

Pure Pressure

Pure Pressure by Pure Rinse Systems is a complete power wash & Reverse Osmosis (RO)/Deionization (DI) system in one. The optional DI cartridge further purifies the RO water for the most demanding spot-free cleaning situations. The power wash system takes in the pure water and produces a time saving water pressure of 1000 psi! Both PUMPTEC pumps are mounted on one motor for a compact, flexible design.

The unit moves easily around a job site — it's frame is only 27" wide and fits through the smallest doorways. The large pneumatic wheels allow easy movement & loading. For storage options, the unit can be stowed horizontally or vertically. Also, the top control panel puts the pressure regulator, pressure gauges and water connections within easy access. The lower tray comes in handy for tool, hose and cord storage while easy access to every major component of the system makes maintenance a breeze.



FEATURES

- High Rejection RO membranes remove 99% of tap water impurities
- Triple pre-filtration for excellent membrane and system protection and long service intervals
- High-efficiency dual pump system is designed to maximize membrane life, pure water production rate and system efficiency
- 1000 psi, 1.75 gpm pure water pressure wash system give powerful, spot-free cleaning
- Both pump systems mounted on one motor for space and weight savings, reduced complexity
- Epoxy coated steel frame made with modular components for fast and simple servicing.
- Vibration isolation mounting for quiet, reduced-vibration operation
- 115 VAC pumping system
- Easy-to-add deionization cartridge option
- "Safety First" design GFCI on each power cord

SPECIFICATIONS

- Capacity: 3000 gpd (Water @ 77°F)
- Pre-filter: 10 x 4.25", 5μ, Pleated
- Carbon filter: 10 x 4.0" Carbon
- Final filter: 10 x 4.25", 1μ, Depth
- Membranes: Thin Film Composite, High Rejection
- Housing: PVC and Glass-filled Polyester
- DI Cartridge: 4.5 x 20", Mixed Bed
- Pumps: PUMPTEC Models 348-210 (2.8 gpm at 200 psi), 348-130 (1.7 @ 1000)
- Motor: 1 1/2 hp, 115/230 vac, 7.2/3.6 fla, 1.15 SF
- Regulators: PUMPTEC 500, adjustable 0-200 psi and 0-1000 psi
- Gauges: Industrial grade, Glycerine filled, SS bodies
- Size: 31d x 27w x 51"h
- Weight: 230 lbs dry



Pure Rinse Systems, Inc
700 McKinley St. NW
Anoka MN, 55303
Ph: 763.433.0303
Fax: 764.433.0404
www.purerinse.com

RO Water Wagon

The RO Water Wagon from Pure Rinse Systems is a self-contained portable water storage and distribution system for use with any of our pure water systems. The tank holds 50 gallons of water; the distribution system can provide flow to multiple applications and allows hose lengths up to 600 feet. The cart is only 24" wide and will fit through standard doorways.

The optional auto-fill switch can be used to power an RO system and shut it down upon achieving system water capacity for total system independence. The optional 12 VDC power system allows remote operation.



FEATURES

- High efficiency pump system is designed to maximize utility and minimize power usage. The system allows 12 volt operation with optimum charging intervals.
- Epoxy coated steel frame made with modular components for fast and simple servicing.
- Vibration mounting of each frame platform for quiet, reduced-vibration operation
- 120 VAC pumping system — 12 VDC pumping system is optional
- Hose length is 300 feet and is non-kinking, non-marking, abrasion resistant and rated for 800 PSI
- Hose reel features a fold-away handle, brake and lock as standard equipment
- Power caddy battery box option has carry handle, power level indicator and auxiliary sockets
- Quick-dump valve quickly empties tank for a fast move to the next job site
- "Safety First" design GFCI on the power cord

SPECIFICATIONS

- Tank: 50 gallon capacity with level indicators
- Pump: PUMPTEC Model 348-190, 2.5 gpm at 200 psi
- Motor: 1/2 hp, 115/230 vac, 7.2/3.6 fla, 1.15 sf
- Regulator: PUMPTEC 500-200, adjustable 0-200 psi
- Gauge: Industrial grade, Glycerine filled, SS body
- Hose: 3/8" id, 300 ft, 800 psi rated
- Hose Reel: 18" diameter, folding handle, brake and lock included
- Pressure Switch: Dual contact, 250v and 25a rated
- Size: 58l x 24w x 52"h
- Weight: 250 lbs dry



Pure Rinse Systems, Inc
700 McKinley St. NW
Anoka MN, 55303
Ph: 763.433.0303
Fax: 764.433.0404
www.purerinse.com

Cart Reel

The Cart Reel from Pure Rinse Systems is a water delivery system that incorporates a hose reel, pump and power system into one complete unit. The patented design was created for its versatility, portability and performance to make getting the job done just that much easier!

The Cart Reel features a high-efficiency PUMPTEC pump that operates at pressures of up to 200 psi. The unit also highlights folding handles on the cart and hose reel for easy, compact storage and large pneumatic tires use in indoor or outdoor areas.

The unit comes with quick-connects at the water connection points for simple set up and storage. It's available with a 13" hose reel and with the hose already installed — or order it without the hose and simply add your favorite hose when you receive the unit.



FEATURES

- High-efficiency pump system is designed to maximize utility and minimize power consumption — for optimized charging intervals
- Stainless steel pump internals for long continuous service life
- Quick prime system for easy draw from a tank
- Epoxy coated steel frame features an industrial-grade finish for long life and exceptional appearance
- Quick-connect water connections
- 12 VDC operation (Battery NOT included)
- Industrial quality stainless steel pressure gauge
- 13" hose reel (150 foot, 3/8" hose capacity)

SPECIFICATIONS

- Pump: PUMPTEC Model 114T, open flow to 2.0 gpm, pressure to 200 psi
- Motor: 12 vdc, xxx amps
- Regulator: PUMPTEC xxx, adjustable 0-200 psi
- Gauges: Industrial grade, Glycerine filled, SS body
- Size: 23d x 21w x 29"h (handle up) 26"h (handle down)
- Weight: 65 lbs dry



Pure Rinse Systems, Inc
700 McKinley St. NW
Anoka MN, 55303
Ph: 763.433.0303
Fax: 764.433.0404
www.purerinse.com

2008 Price List

RO Anywhere

PN

900 GPD	50001	\$3050
1800 GPD	50012	\$3650
2700 GPD	50006	\$4150

RO Tank

3000 GPD	50003	\$4200
-----------------	--------------	---------------

RO Trolley

2700 GPD	50007	\$10,250
Includes DI		

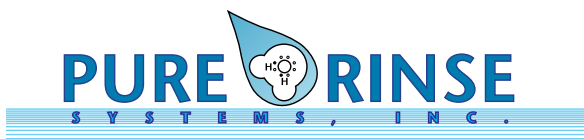

Pure Rinse Systems, Inc.
700 McKinley st. NW
Anoka MN, 55303
Ph: 763.433.0303
Fax: 764.433.0404
www.purerinse.com

2008 Price List

Cart Reel

13" Hose Reel/Cart/Pump System (12 VDC)	PN 80226	\$1250
--	--------------------	---------------

Replacement Parts and Accessories

Filter/DI Cartridges

5 Micron Cartridge, Pleated	55005	\$39
1 Micron Cartridge, Spun Poly	55004	\$34
Carbon Cartridge	55001	\$37
DI Cartridge, Mixed Bed	55015	\$212

RO Membranes, TFC,

2.5" x 40, 650 GPD	55022	\$406
4x21, 900 GPD	55006	\$252
4x40, 1900 GPD	55052	\$610

Stainless Steel Housings

2 1/2 x 40, 650 GPD	55053
4x 21, 900 GPD	55054
4x40, 1900 GPD	55055

Instrumentation

TDS Meter, Hand-held, 0-2000 PPM	55014	\$39
----------------------------------	-------	------

Notes:

- Membrane flow ratings are maximum performance under ideal conditions. Flow is rated at a feed water temperature of 77 Degrees F. Lower temperatures result in lower pure water production rates. Higher temperatures are not recommended and may damage the membrane.
- All units include a hand-held DS meter and filter housing wrench
- Batteries are not included with any 12 volt system

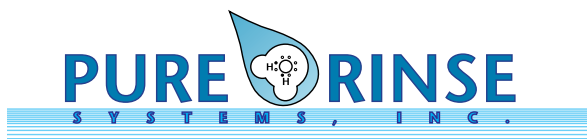

Pure Rinse Systems, Inc.
700 McKinley st. NW
Anoka MN, 55303
Ph: 763.433.0303
Fax: 764.433.0404
www.purerinse.com

Window Cleaning System Configurations

RO Anywhere

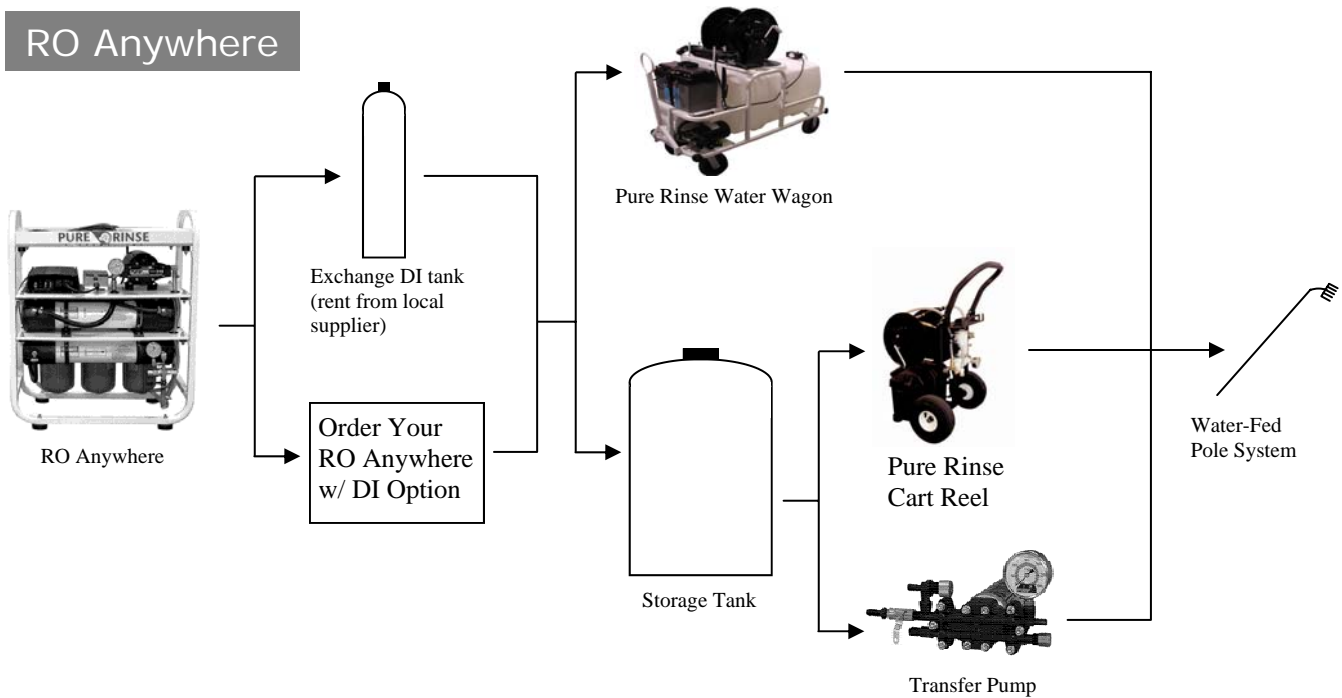

RO A La Kart

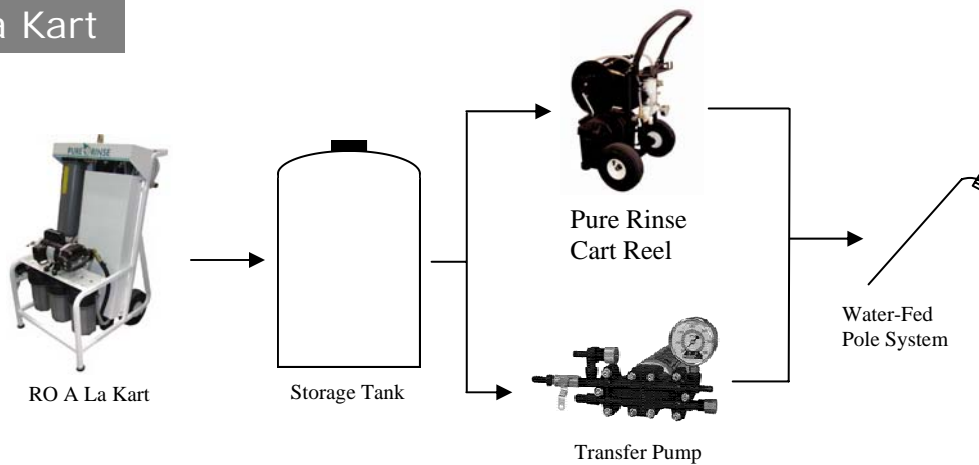

Pure Rinse Systems, Inc
700 McKinley St. NW
Anoka MN, 55303
Ph: 763.433.0303
Fax: 764.433.0404
www.purerinse.com

Window Cleaning System Configurations

RO Tank

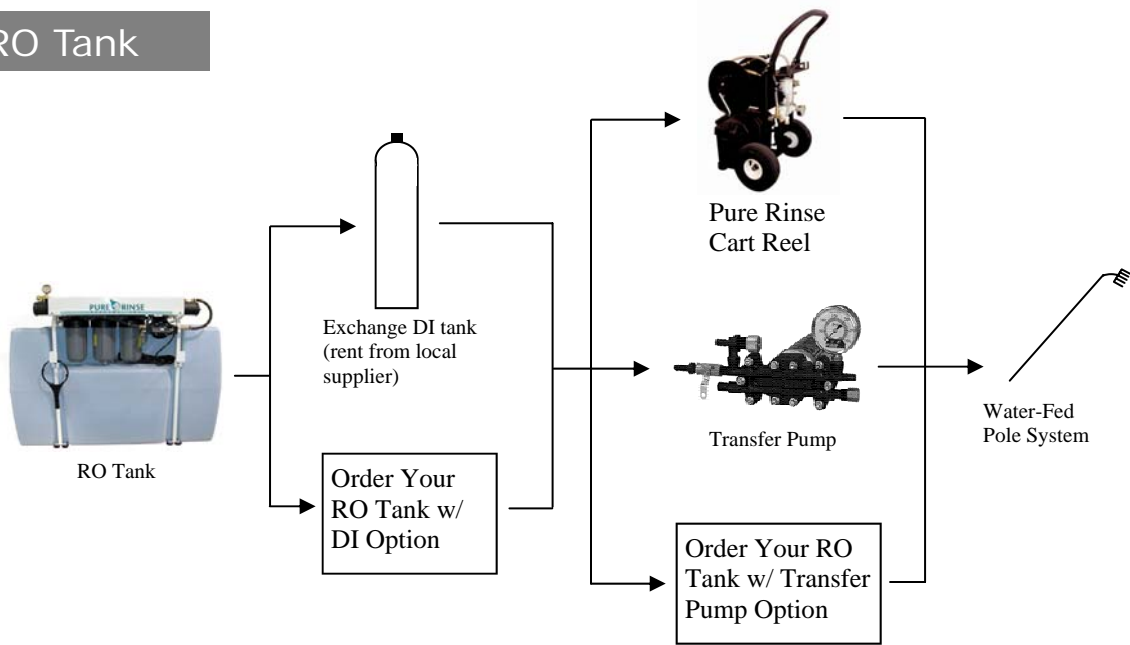

RO Trolley

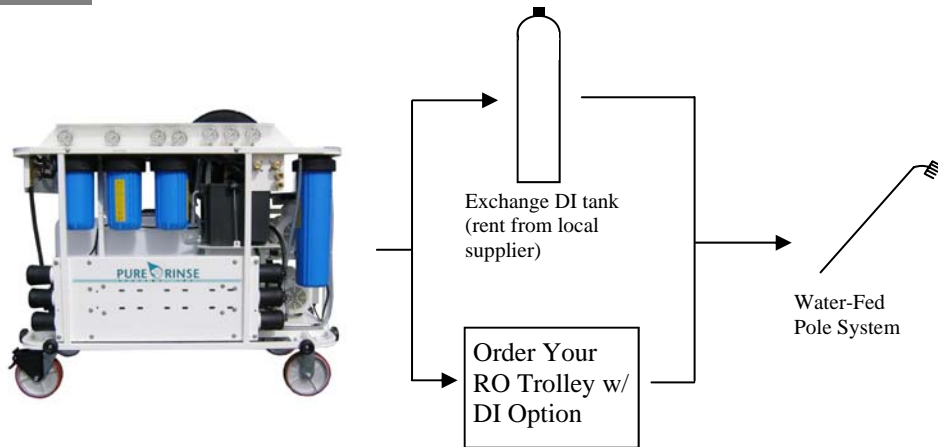

Pure Rinse Systems, Inc
700 McKinley St. NW
Anoka MN, 55303
Ph: 763.433.0303
Fax: 764.433.0404
www.purerinse.com